

Technical Information

The Predator PMFLN5-AGM is a premium quality battery designed for vehicles equipped with Idle Stop Start (ISS) technology. For reliable ISS function and battery life it is critical that an AGM is installed whenever it is specified by the manufacturer.

Predator AGM's ensure there is always enough energy to operate vehicle accessories while maintaining a power reserve to start the engine when required. Every AGM cell is fitted with a one-way valve to ensure optimum performance while allowing the cell to vent if needed.

When compared to a flooded battery, a Predator AGM will deliver a significantly longer service life and is also highly resistant to vibration. Predator AGM's can replace a flooded battery in most applications when higher performance and durability are needed.

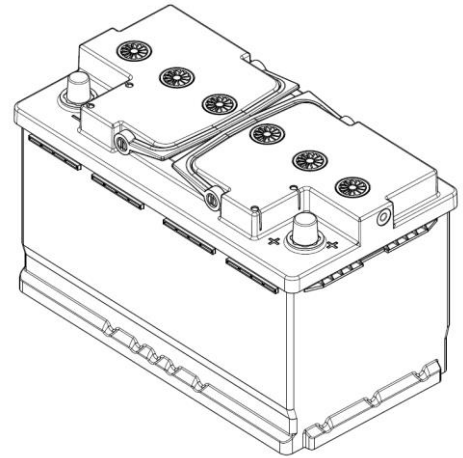

Features & Benefits

- Ideal for ISS and high performance applications
- Significantly longer cycle life vs flooded batteries
- Spill proof design
- Superior vibration resistance

Applications

Idle Stop Start Vehicles
Prestige Passenger Cars
High Performance Upgrade

Technical Specifications

Battery Type	Absorbent Glass Mat	Case Material / Colour	Polypropylene / Black
Voltage	12V	Lid Type	VRLA
Capacity (20Hr)	80Ah	Plate Type	Full Frame Positive & Negative Grids
CCA (-18°C, SAE)	800A	Separator Type	Glass Mat
Reserve Capacity (25A, SAE)	140 minutes	Assembly Layout	RH Positive [- +]
		Terminal Type	SAE Standard
Overall Size (LxWxH)	315 x 175 x 190mm	Case Size	Din77H, LN4
Nominal Weight	22.6kg	Ledges	Long & Short Side